



MV22 Installation Guide

By Matthew Marston

MV22 Overview

The Cisco Meraki MV22 is a network camera that is exceptionally simple to deploy and configure due to its integration into the Meraki Dashboard and the use of cloud augmented edge storage. The MV family eliminates complex and costly servers and video recorders required by traditional solutions which removes the limitations typically placed on video surveillance deployments.

Package Contents

In addition to the MV camera, the following are provided:

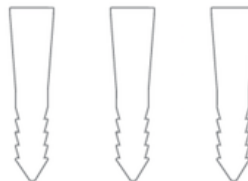
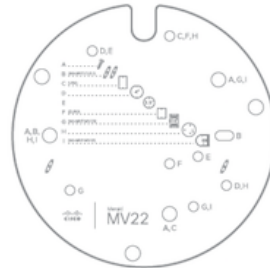
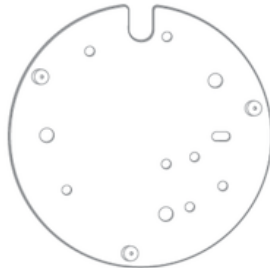
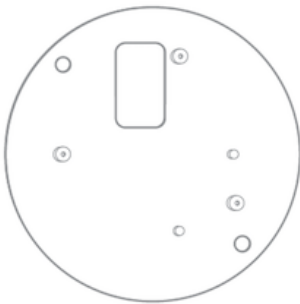
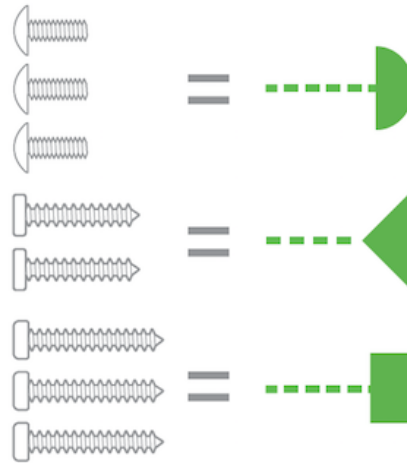
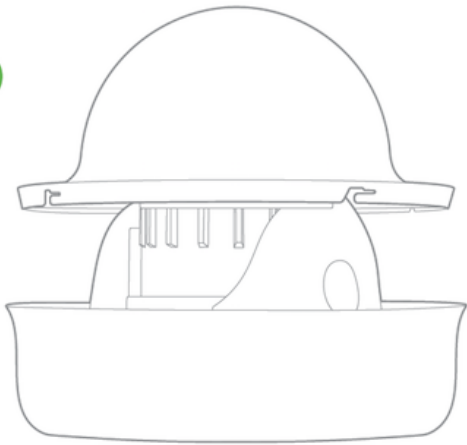

From top-left to bottom-right:

- 1 x MV22
- 3 x mount plate stacking screws
- 2 x 4x4 junction box mount plate screws
- 3 x wall screws
- 1 x 4x4 junction box mount plate
- 1 x base mount plate
- 1 x base mount wall template
- 1 x T6 Torx key
- 3 x wall anchors

Powering the MV22

The MV22 features a 1000BASE-TX Ethernet port and requires 802.3af PoE minimally for operation. Route the Ethernet cable from an active port on a PoE switch or PoE injector.

Note: Power over Ethernet supports a maximum cable length of 300 ft (100 m).

Pre-Install Preparation

You should complete the following steps before going on-site to perform an installation:

Configure Your Network in Dashboard

The following is a brief overview only of the steps required to add an MV22 to your network. For detailed instructions about creating, configuring and managing Meraki Camera networks, refer to the online documentation (<https://documentation.meraki.com/MV>).

1. Login to <http://dashboard.meraki.com>. If this is your first time, create a new account.
 2. Find the network to which you plan to add your cameras or create a new network.
 3. Add your cameras to your network. You will need your Meraki order number (found on your invoice) or the serial number of each camera, which looks like Qxxx-xxxx-xxxx, and is found on the bottom of the unit.
 4. Verify that you the camera is now listed under **Cameras > Monitor > Cameras**.
-

Check and Configure Firewall Settings

If a firewall is in place, it must allow outgoing connections on particular ports to particular IP addresses. The most current list of outbound ports and IP addresses for your particular organization can be found [here](#).

DNS Configuration

Each MV22 will generate a unique domain name to allow for secured direct streaming functionality. These domain names resolve an A record for the private IP address of the camera. Any public recursive DNS server will resolve this domain.

If utilizing an on site DNS server, please whitelist *.devices.meraki.direct or configure a conditional forwarder so that local domains are not appended to *.devices.meraki.direct and that these domain requests are forwarded to Google public DNS.

Assigning IP Addresses

At this time, the MV22 does not support static IP assignment. MV22 units must be added to a subnet that uses DHCP and has available DHCP addresses to operate correctly.

Installation Instructions

Note: Each MV22 comes with an instruction pamphlet within the box. This pamphlet contains detailed step by step guides and images to assist in the physical install of the camera. A pdf of the pamphlet can be found [here](#).

Note: During first time setup, the MV22 will automatically update to the latest stable firmware. Some features may be unavailable until this automatic update is completed. This process may take up to 5 minutes due to enabling of whole disk encryption.

Mounting Instructions

For most mounting scenarios, the MV22 wall mount provides a quick, simple, and flexible means for mounting your device. The installation should be done in a few simple steps:

Note: Leave protective plastic cover on the optical dome, as this will prevent the optical dome from any damage during installation.

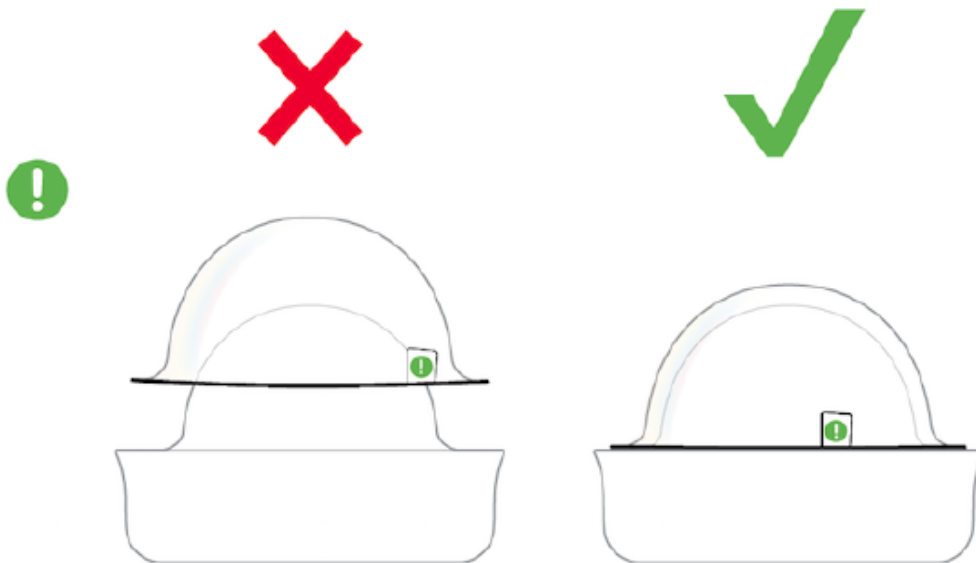

1. If you're mounting to a 4x4 junction box, first route the Ethernet cable through the hole and affix the 4x4 junction box mount plate using the two white screws. Once done, attach the base mount plate onto the 4x4 junction box mount plate using the three provided screws.

If wall mounting, use template to determine mounting hole locations before screwing in the mount plate. Peel backing from mount template to stick on wall. Use template holes marked with the letter "A" for standard wall mounting. Screw the mounting plate onto the wall in pre-determined locations using the provided wall screws.

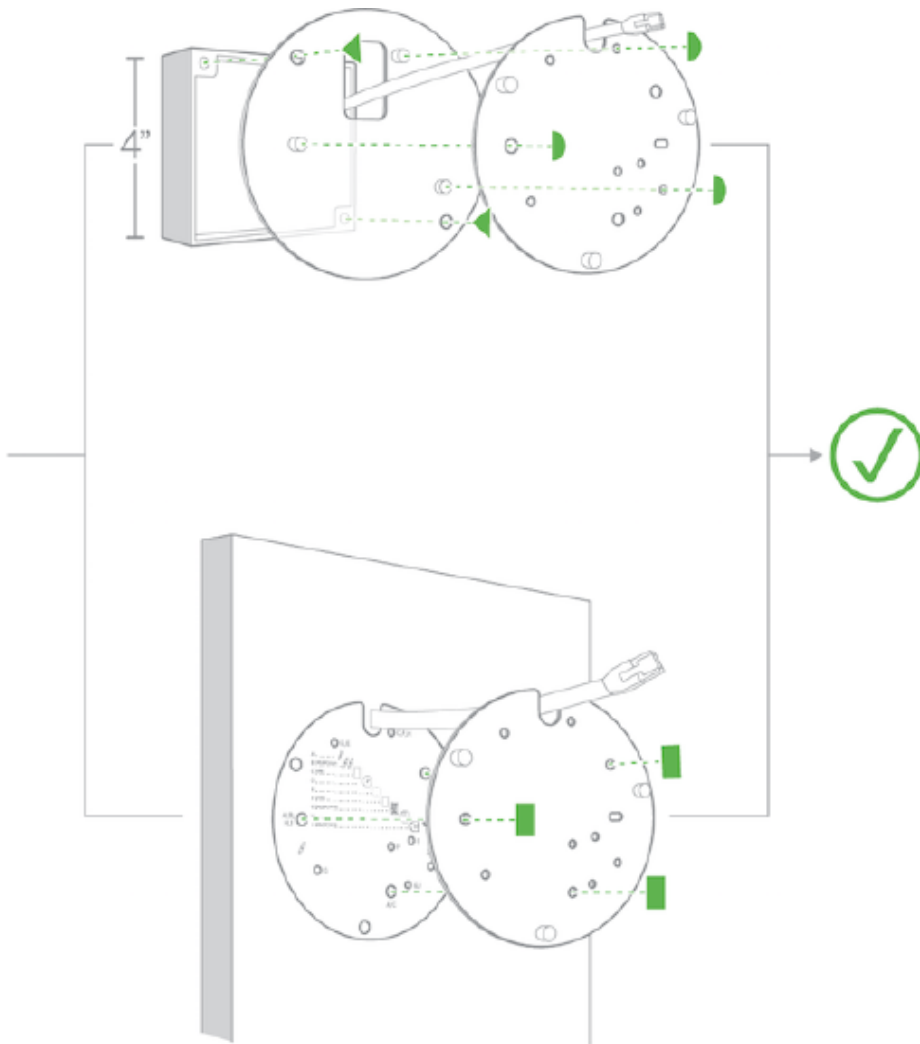

2. Connect PoE cable to camera. For cords that will exit the top of the camera, remove the mouse hole cover before routing the cable.

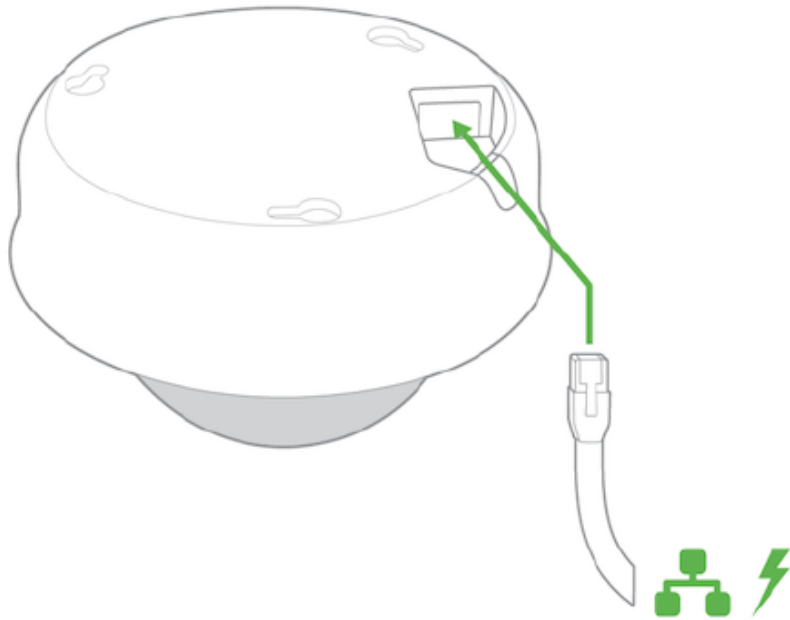

3. Turn the optical dome counter clockwise to unlock from the body and pull outward to remove.

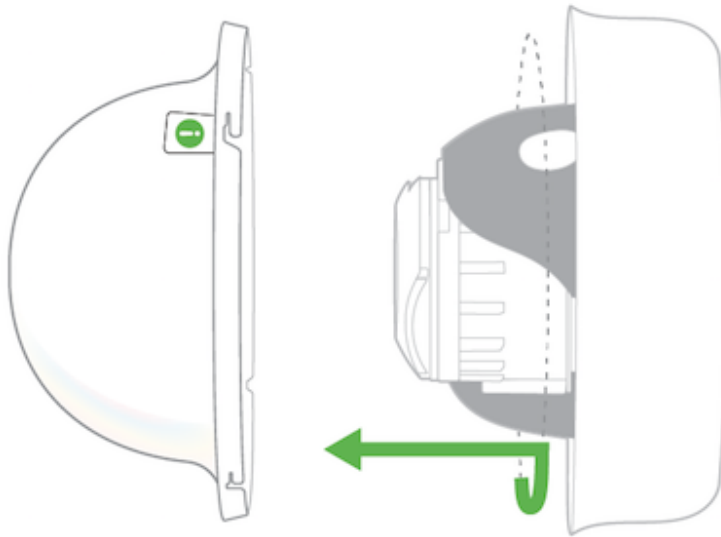

4. Slide camera over top of mount plate and rotate onto mount plate hooks. Secure with Phillips or Torx head safety screw.

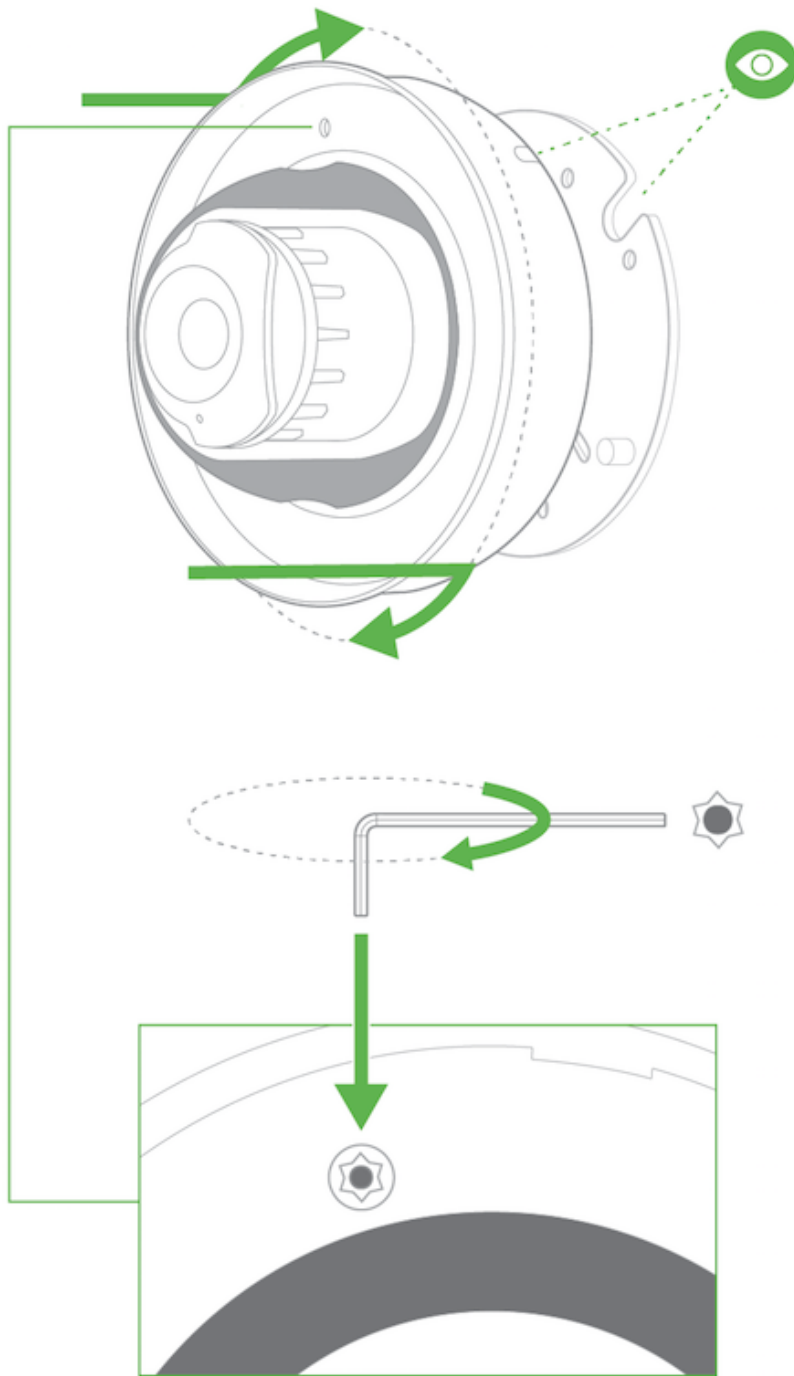

5. Observe the status LED on the left side of the camera lens assembly and ensure the camera is connected via Ethernet (solid green) or WiFi (solid blue). A MV must first be provisioned over a wired Ethernet connection before it can be deployed wirelessly. For information on how to connect via WiFi, see the setup guide [here](#).

Your MV22 is equipped with a LED light on the front of the unit to convey information about system functionality and performance.

The various status conditions of a MV are indicated by the following colors and patterns:

- Rainbow (solid, rotating through colors) - MV is booting up.
- Flashing Blue - MV is searching for WiFi network(s).
- Flashing Green - MV is upgrading or initializing for the first time.
- Solid Green - MV is connected via Ethernet.
- Solid Blue - MV is connected via WiFi.
- Solid Violet - MV has audio recording enabled.
- Solid Amber - MV has an issue and may need replacement.

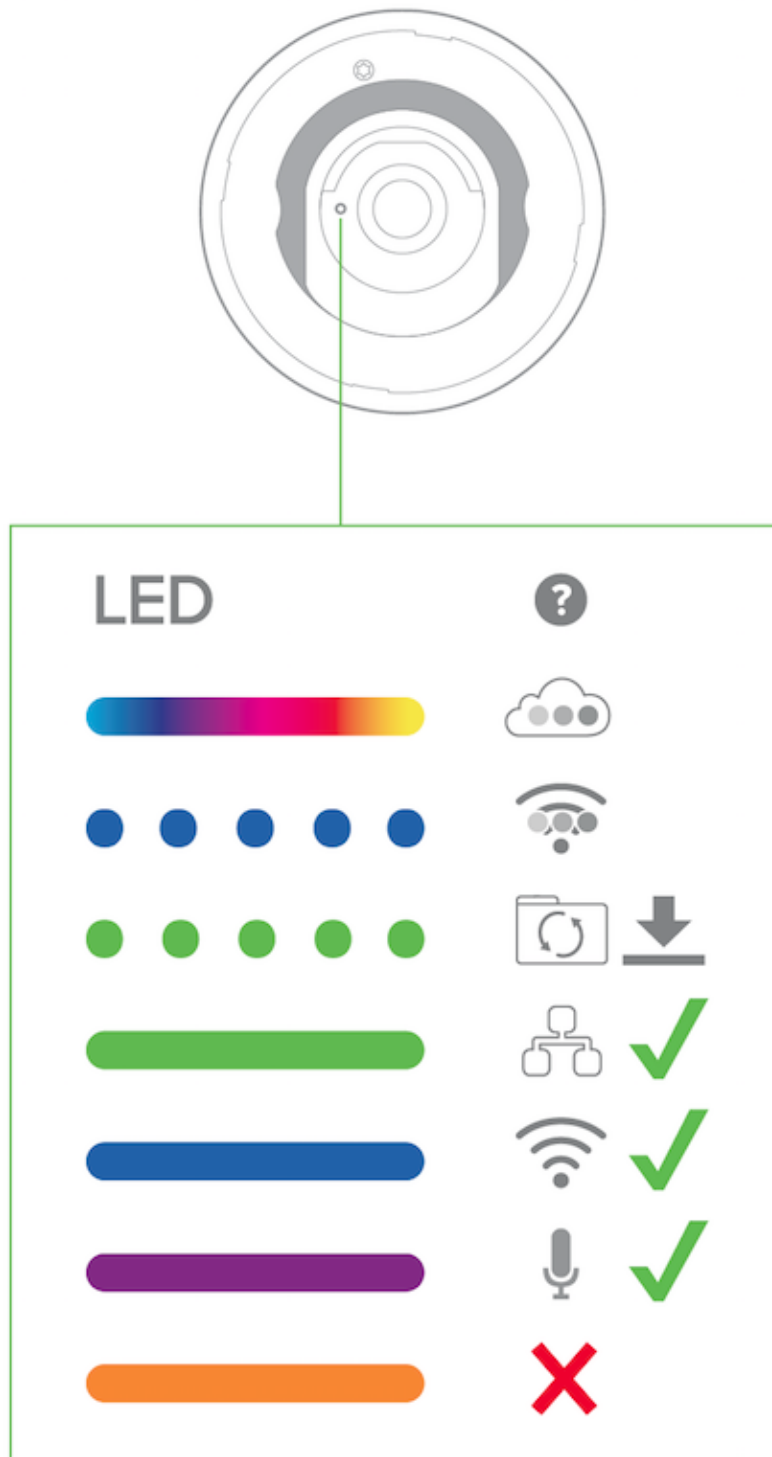

6. Aim the lens. Look through the camera on the Meraki Dashboard to fine tune the picture. The camera sensor and lens unit can be physically tilted through a range of 65 degrees, rotated through a range of +/-90 degrees, and panned through a range of 354 degrees. The image can only be rotated by 180 degrees in software and no other adjustments can be made. Zoom and focus can be adjusted remotely and can not be adjusted physically on the camera. For more information on zooming, refer to the [adjusting the Field of View article](#).

Note: Never adjust or remove the rubber lens gasket or protective lens guard.



7. Replace optical dome and turn clockwise to lock. Remove the protective plastic cover.

